

Fibre Raceway

For the Data Centre

& Industrial Sector



Data Centre Solutions & Services

Protecting Your Network with
racks, power, CREMS, access
control & analysis

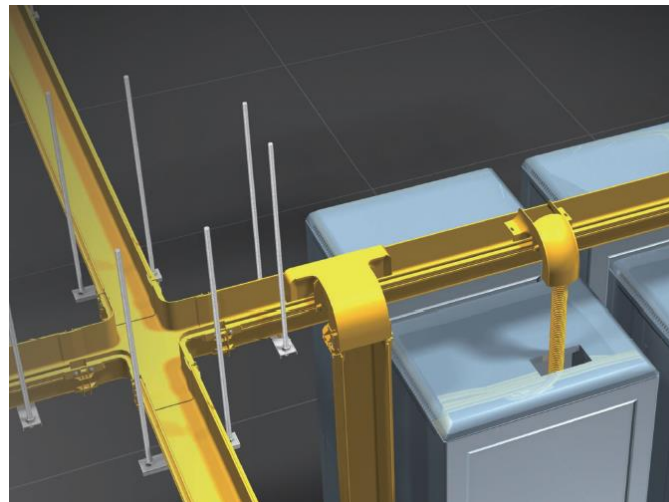

Overview

The Fibre Raceway system is designed to protect & route optical fibre cable from the network cabinets/ODF to the equipment on the computer room/industrial floor.

Flame retardant rated at GB/T2048-2008 FV-0

Made of PVC and ABS plastics

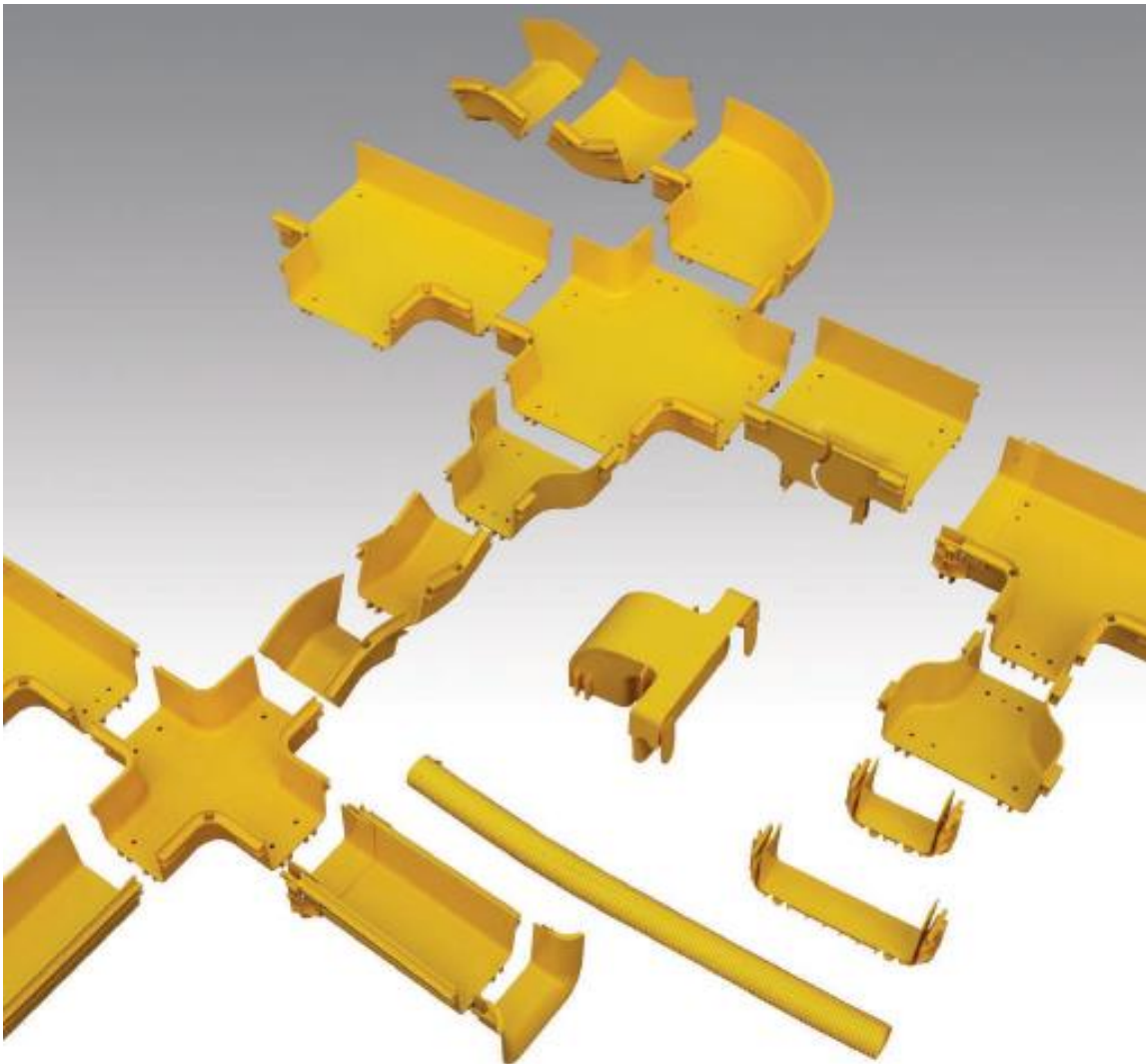

Dimension:

- Height: 100mm
- Width: 120mm
- Length: 2000mm

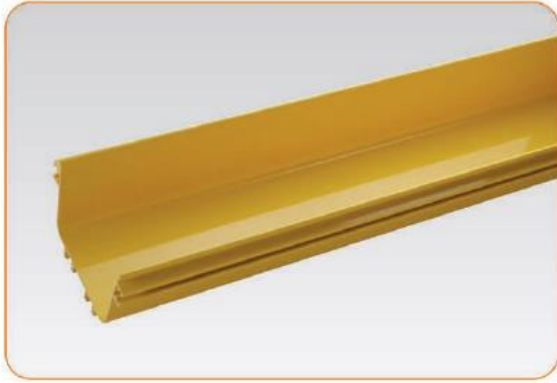

Fiber loading capacity

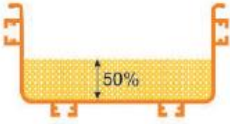
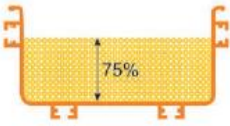
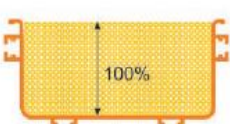
	2mm Fiber	3mm Fiber
	955	424
	1433	636
	1910	848

Dimension:

- Height: 100mm
- Width: 240mm
- Length: 2000mm

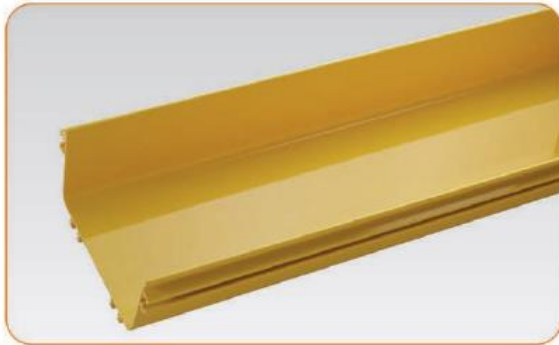

Fiber loading capacity

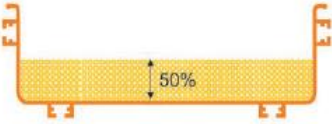
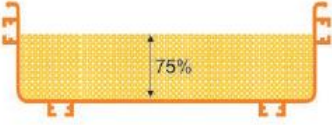
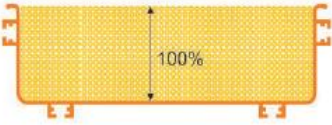
	2mm Fiber	3mm Fiber
	1910	849
	2866	1273
	3821	1698

Connector



Horizontal 90° Bend



Horizontal Tee

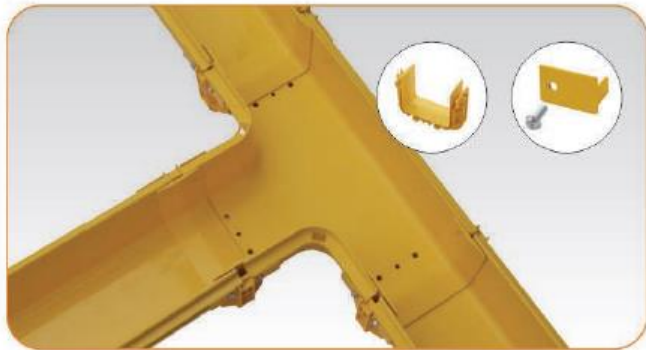

Horizontal Cross

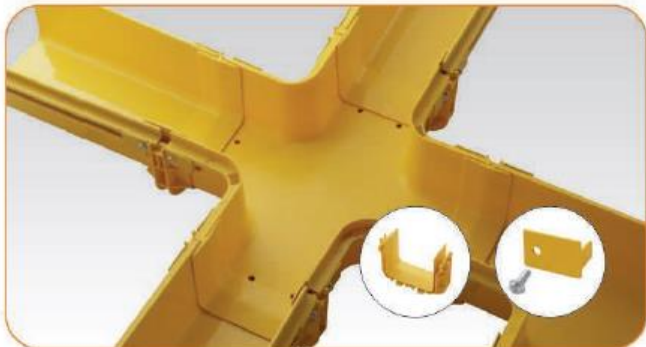

240 to 120 Vertical T

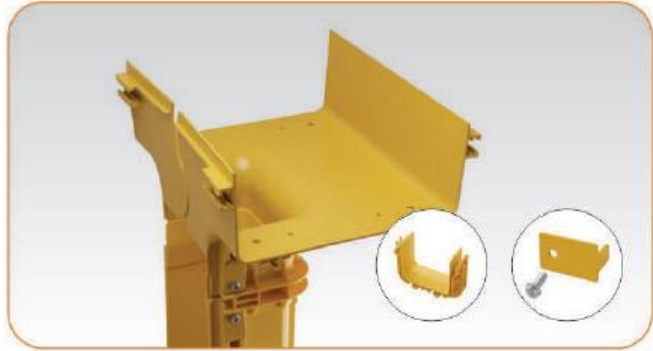

240 to 120 Level T

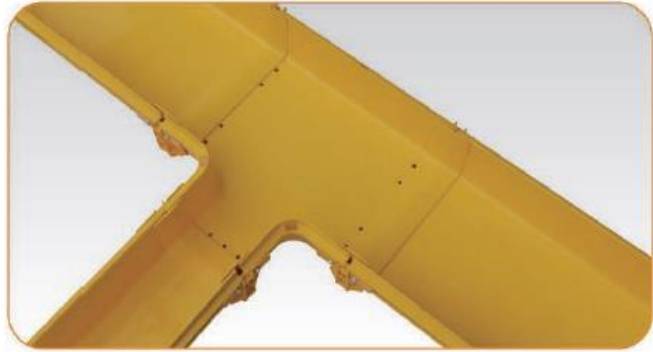

Reducer

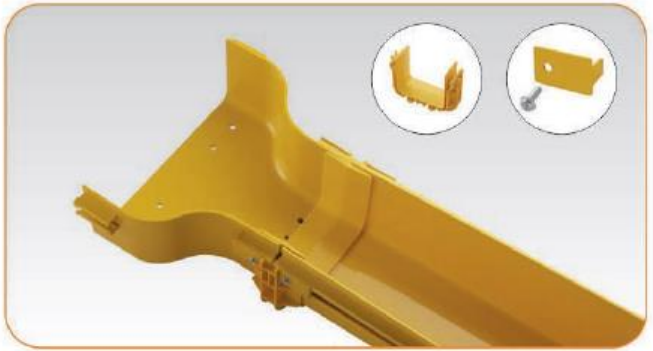

Trumpet Spillout





External Riser 45°

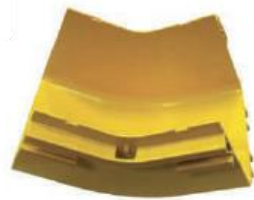

Internal Riser 45°

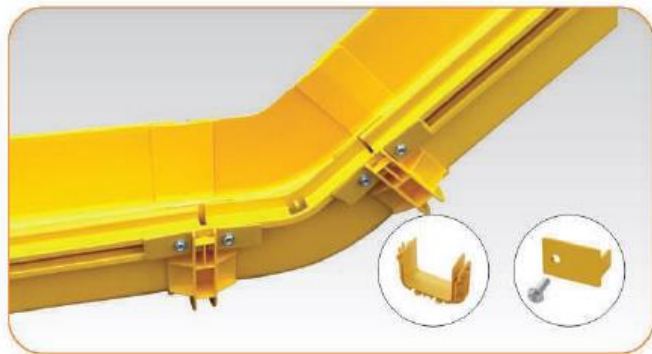

End Cap

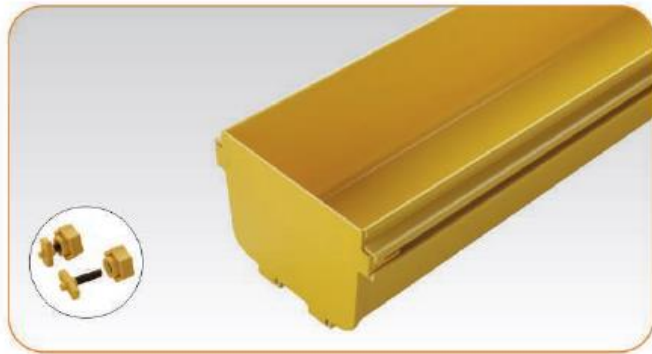

Movable Cable Exit Kit With Tube





Big Movable Cable Exit Kit



Cabinet top stand

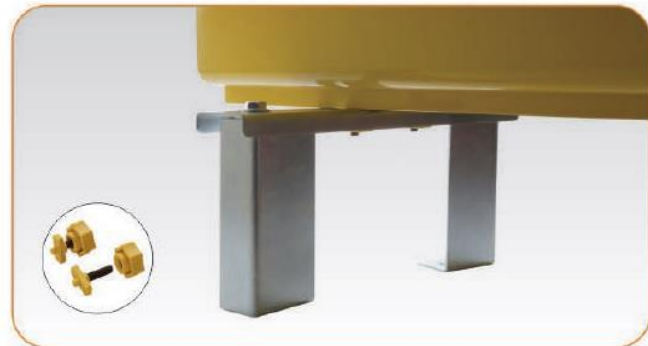
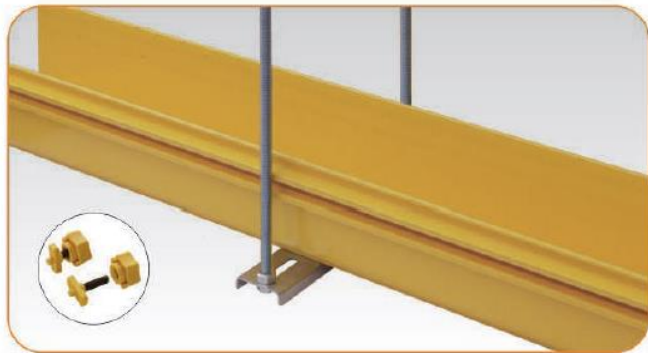

Hanging Set



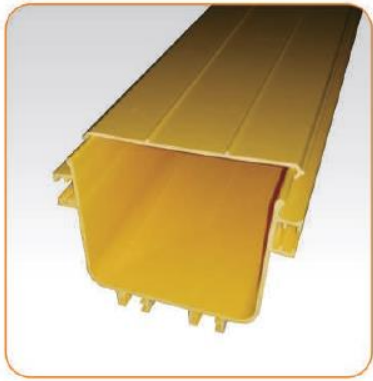

Fiber runner cover

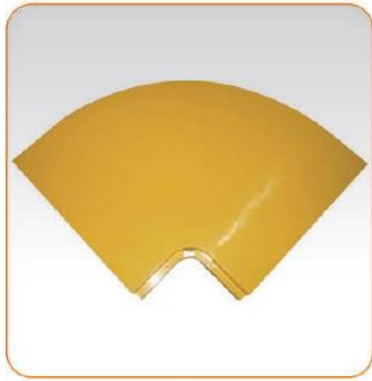

90° Cover

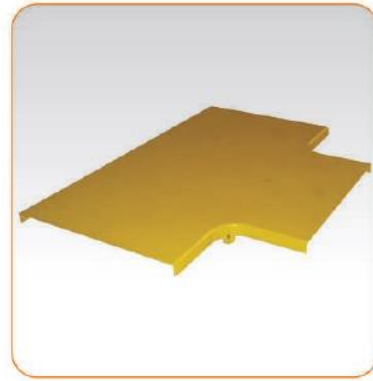

Horizontal T cover

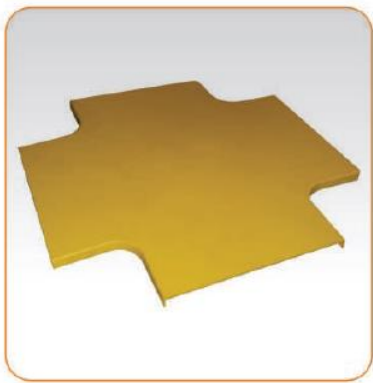

Horizontal cross cover

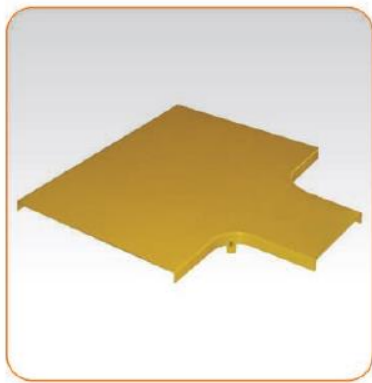

240-120 Horizontal T cover



45° Cover



Internal riser cover

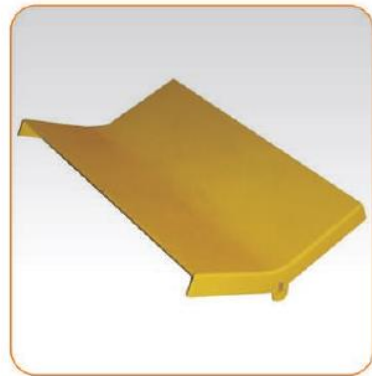

External riser cover



Recuder cover

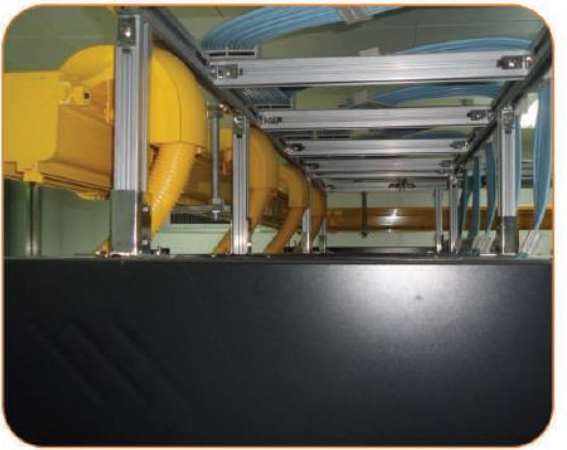
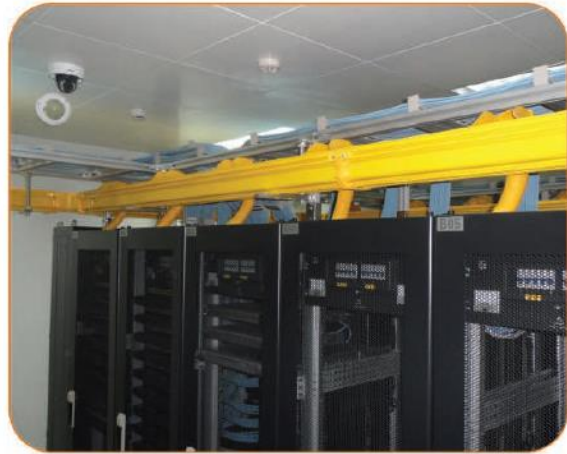

Data Centre Solutions & Services

